

Outbound Road Standards

Regulations for external road transport of steel products



Blank page

Introduction

- This new document replaces the Outbound Road Standards 3.0.
- This standard contains the relevant information for a haulier that undertakes road transport of product under the responsibility for or ordered by Tata Steel Strip Products, Tata Steel Colours or Tata Steel Packaging.
- The method of transport has a direct bearing on the quality and safety to Tata Steel products and employees. Therefore, Tata Steel requires its partners to uphold the standards outlined in this document.
- While extensive measures have been taken to provide guidelines, they should be treated as minimum safety and quality standards and do not indemnify suppliers from taking additional measures to ensure the safety and quality of service.
- Where applicable the word 'driver' also covers Shunter requirements.

Table of Contents

Part 1 Site access/procedures

1.1	Access Control	1-1
1.2	Tata Steel Site Rules	1-2
1.3	Personal Protection Equipment	1-3
1.4	Personal Behaviour	1-4
1.5	Tata Steel Procedures	
1.4.1	“Loadsafe” Standards	1-6
1.4.2	Loading procedures	1-6
1.4.3	Trailer Uncoupling Standards/Standards	1-7
1.4.4	Point of Delivery	1-7
1.4.5	Reporting	1-7

Part 2 Equipment requirements

2.1	General Requirement	2-1
2.2	Vehicle Requirements	
2.2.1	DME	2-1
2.2.2	Handbrake Alarm	2-1
2.2.3	Trailer Headboard	2-2
2.2.4	Trailer Floor	2-2
2.2.5	Coil well	2-2
2.2.6	Stanchions (coil securing posts)	2-3
2.2.7	Lashing points	2-3
2.2.8	Weather superstructure	2-3
2.2.9	Roof Pole	2-4
2.2.10	Sheeting	2-4
2.3	Securing Equipment Requirements	
2.3.1	Webbing straps and ratchets	2-5

2.3.2	Transport chains and tensioners	2-5
2.3.3	Webbing strap edge protection	2-6
2.3.4	Anti-slip matting	2-6
2.3.5	Horizontal wooden and metal posts	2-7
2.3.6	Timbers and wooden dunnage	2-7
2.3.7	Coil Cradles	2-8
2.3.8	Stillages	2-8
2.4	Technical Information Sheets (TIS)	
2.4.1	Description	2-10

Part 3 Co-loads (additional cargo)

3.1	Types of Additional Cargo	3-1
3.2	Prohibited Co-loads	
3.2.1	Items not permitted	3-1
3.2.2	Hazardous co-loads	3-2
3.2.3	Harmonisation System (HS) codes	3-3
3.3	Loading and Unloading	3-4
3.4	Load Configuration and Securing	3-4
3.5	Exceptions	3-4

Part 4 Return Cargo

4.1	Responsibility	4-1
4.2	Packaging	4-1
4.3	Securing	4-1

Part 5 Securing Methods

5.1	Description	5-1
5.2	Securing Methods/Guidelines	5-1
5.3	Basic Principles	5-1
5.4	Winter Weather Conditions	5-1

Part 6 Accidents and Incidents

6.1	Accidents	6-1
6.1	Unauthorised access and malicious damage	6-1

Part 7 Organisation and management

7.1	Application	
7.1.1	Responsibility	7-1
7.1.2	Application	7-1
7.1.3	Inspection	7-1
7.1.4	None conformance system	7-2
7.2	Document Control	
7.2.1	Publication method	7-3
7.2.2	Validity	7-3
7.2.3	Archive	7-3
7.2.4	Authorisation	7-3

Blank page

1. Site access/procedure

1.1 Access Control

A driver must have the following documents and information to gain entrance to the loading locations of Tata Steel:

- Identification document (passport or national id card)
- Tata Steel load reference or transport number (as applicable).
- Total weight of the load.

Tata Steel sites in the UK have extra requirements with regards to site access, please refer to collection plans where available. These requirements include the following: -

- Load Restraint Training Card (where applicable).
- Number of items to be collected.
- Destination.

Access will be refused when the driver:

- Has a any traces of alcohol in their body (blood alcohol level above 0.0mg/l)
- Is accompanied by pets or unauthorised passengers.
- Demonstrates inappropriate behaviour.

Drivers are obliged to show their personal protection equipment when asked to do so either when requesting access to or at any time whilst on the Tata Steel site.

1.2 Tata Steel Site Rules

Each Tata Steel Europe site is unique. Whilst Tata Steel strives to introduce global Site rules that apply to every Tata Steel Europe site, in practice this is not always possible.

Below you will find a number of rules that apply to all locations where this document is in force: -

- No sleeping is permitted on site. Ensure you have enough hours left on your tachograph to enable you to be loaded and leave site before your hours run out.
- The use of mobile phones including hands free devices, CB radios and other potential distractions are not permitted when driving on Tata Steel sites.
- Vehicle radios must be switched off whilst on Tata Steel sites.
- Rail traffic ALWAYS has right of way on Tata Steel sites, at crossings with traffic light signals, if the red lights are showing you must stop and wait for the lights to go out before proceeding.
- Tata Steel operate a Zero Tolerance Policy towards drugs & alcohol. You must not be under the influence of or in possession of any drugs or alcohol on Tata Steel sites.

Further information regarding specific sites can be found wither in the local site rules document or in the local collection plan.

Ask your Tata Steel contact for these rules before attempting to gain access to a site for the first time.

1.3 Personal Protection Equipment

Drivers must have and use the following personal protection equipment:

- Hard hat to EN 397: 2012
Refer to collection plans for site specific colour requirements.
- Safety shoes with reinforced toecaps to EN 20345: 2011 type S3.
- Clothing to cover the entire body. Shorts or short sleeves are not allowed.
- Reflective clothing/vest.



The following additional personal protection equipment is required depending on the loading location:

- Safety goggles to EN 166: 2002
- Hearing protection
- Refer to local rules for requirements
- Chin Strap



The use of the following personal protective equipment is required when handling sharp objects:

- Industrial Safety gloves



1.4 Personal Behaviour

Drivers, including co-drivers are required to work in a safe way and behave according to general standards at both loading and unloading locations.

Drivers must:

- Adhere to the Tata Steel General Safety Standards.
- Wear a valid Admission Pass/Site Induction Card (as applicable) where it can be clearly seen.
- Where issued, carry their Load restraint training record card.
- Wear the prescribed personal protection equipment.
- Strictly follow the safety regulations at the loading locations.
- Always apply the handbrake whenever the vehicle is parked.
- Only drive their vehicle into the loading bay after receiving permission from the dispatch staff, either verbally or via a traffic light system.
- Report to the dispatch office on arrival.
- Stay in the vicinity of the vehicle.
- Always use the roof pole to open or close the roof of the trailer.
- Strictly follow the instructions of the dispatch staff.
- Position themselves so that they are visible to the loading personnel during loading.
- Secure the load, as a minimum, so as referred to in the Tata Steel Road Standards.
- Fill in and sign the CMR (waybill) after the loading is completed and before departure.
- Make remarks on the CMR when the load demonstrates material/packaging damage.
- Notify the dispatch staff when departing.
- Report any safety issues.

Drivers must not:

- Open or close the roof in an unsafe way. Never climb on the weather hood.
- Drive, even for short distances with the trailer door open.
- Be in the red or yellow areas of the exclusion zone during loading.
- Touch the load or the hoist, or guide these by hand.
- Operate installations belonging to Tata Steel, for example cranes and fork-lift trucks.

- Enter any other part of the loading bay other than where the loading takes place.
- Urinate elsewhere than on a therefore equipped place (toilet).

1.5 Tata Steel Procedures

1.5.1 “Loadsafe” Standards

Tata Steel Europe operates according to “Loadsafe” Standards, which cover four main aspects of the transport of steel and other materials. These are:

- Exclusion Zones and Safe Havens.
- Working at Height.
- Reversing.
- Load Restraint

1.5.2 Loading Procedures

- The tractor unit park brake must be applied, the engine switched off and the key removed from the ignition before the driver leaves the cab.
- Where installed the trailer should be parked with the parking blocks between the trailer wheels.
- On sites where uncoupling is allowed the park brake must be applied to all parked trailers.
- During loading, drivers must stay in the designated Safe Haven (Green Zone), unless otherwise instructed by the loading team.
- Tautliners/Swap body units must be opened prior to loading. If the trailer is moved after opening, the doors must be closed, and curtains secured.
- Where possible drivers should always work from ground level. If however this is not practicable where available working at height provisions such as working platforms should be used.
 - Drivers should familiarise themselves with the local platform operations.
 - Movable platforms should always be pushed into position leaving the minimum gap between the trailer and the platform as possible.
 - Always apply the platform brakes & check that they are working before use.
 - Access the trailer via the platform steps provided or from the edge of the lorry dock.
 - In certain areas you may be required to pull the platforms away from the loading area after loading.

- It is essential that any defect found with a platform is reported to the local Tata Steel representative.
- Working on trailer beds with the side open is prohibited unless approved fall protection measures are in place, in accordance with Site rules and procedures.
- The driver must check the load for integrity and must raise any discrepancies with the loading team before leaving the loading point.
- The driver should never accept the load if they feel it is not loaded correctly

1.5.3 Trailer Uncoupling Standards/Procedures

Coupling and uncoupling has been identified as an activity with a relative high risk. Unsafe practices often lead to vehicle runaway or trailer rollaway situations. They can result in serious and fatal injury to the driver or others, and costly damage to both vehicles and property.

- Coupling and uncoupling is only allowed at certain designated locations and only when permission has been received to do so.
- Many operators have developed process for (un)coupling and these should be adhered to where available. The main points with regards to safety are listed below: -
 - Always apply the tractor unit parking brake, stop the engine and remove the keys when leaving the cab.
 - Ensure that the trailer parking brake is applied at all times during the coupling and uncoupling process.
 - When coupling a trailer, the checks/operations below should be undertaken: -
 - Carry out a visual check that the 5th wheel jaws have engaged correctly and fit the security "dog clip" or other safety device.
 - Carry out a second test that the 5th wheel jaws have engaged by selecting a low forward gear and with the trailer brakes still applied slowly pulling forward
 - Before leaving the uncoupled trailer, walk round it to check that it is in a safe condition.

1.5.4 Point of Delivery

- Drivers are representing Tata Steel Europe when making deliveries to customers and therefore should ensure that the same high standards applied on a Tata site are also applied at customer sites

1.5.5 Reporting

- To allow Tata Steel to continuously improve and learn from any failings it is vital that any issues are reported to the Logistics team. This could refer to a number of different issues and a few examples are listed below:
 - An unsafe condition or act seen within a Tata Steel site
 - An unsafe condition or act seen at a customers site
 - Incorrect information on Tata Steel's or Customer's documentation
- Any issues on a Tata Steel site must be reported immediately to the local area supervisor.
- Any incident either on a Tata Steel or Customers site, no matter how small must be reported to the local area supervisor and to the Tata Steel contact.

2. Equipment requirement

2.1 General Requirement

- The vehicle and equipment must be maintained in such a way that it is safe to work on and with.
- Vehicles with insufficient or defective equipment will not be loaded
- The trailer must be clean and dry when the vehicle arrives for loading. Clean means: free of odour, dirt and fluids.

2.2 Vehicle Requirements

2.2.1 DME (Diesel Motor Emissions)

- Vehicles loading in IJmuiden must meet requirements as described in the Tata Steel document RVME 3.33 which can be found at the following web site (NL): - [http://www.tatasteel.nl/veiligheid/download.php?path=assets/files/regelgeving/rvme/voorschriften_en_procedures/3.33 Toegangsbeleid Dieselmotor emissie \(DME\).pdf](http://www.tatasteel.nl/veiligheid/download.php?path=assets/files/regelgeving/rvme/voorschriften_en_procedures/3.33%20Toegangsb%ebl%e9id%20Dieselmotor%20emissie%20(DME).pdf)
 - This requires that vehicles are fitted with a class Euro-4 or higher diesel engine. Euro-3 engines will only be allowed when fitted with a particulate filter with a collection efficiency of at least 70%. Vehicles with an emissions class lower than Euro-3 will not be allowed.

2.2.2 Handbrake alarm (where applicable)

All Long Goods Vehicles (LGV's) operating on a Tata Steel UK site must have a tractor unit / vehicle handbrake alarm fitted.

- The alarm must operate regardless of ignition key state.
- The alarm must sound if the handbrake is OFF and the driver door is opened. Activation if the passenger door is opened is recommended but not mandatory.
- The internal alarm sounder must be a minimum 90dB.

2. Equipment requirement

- The alarm must be clearly audible outside the vehicle. In practice this will normally require an external sounder as an internal sounder will not be clearly audible if doors are closed.
- The only action to stop the alarm sounding must be to put the handbrake ON..

2.2.3 Headboard

- If used to restrain the load the headboard strength must be atoneable by form of a certificate or plaque. The head board must be well maintained and undamaged.
- Headboards on trailers used to transport Tata Steel products shall be high enough to prevent any part of the load from sliding over it.

2.2.4 Trailer Floor

- The loading platform should be flat, solid and well-maintained.
- When a trailer with a coil well is to be used to transport general loads on a flat floor it must be possible to fully cover the well to present a solid loading platform. There should be no missing or broken boards for covering a coil well. Well boards must have a support from to support the weight of the load.
- The trailer bed must be clean and dry when the vehicle arrives for loading. Clean means: free of odour, dirt and fluids. If the Dispatcher decides the trailer is not clean it will not be loaded.
- There should be no risk of the load becoming wet from underneath the trailer
- Refer to Technical Information sheet TIS-0003 for further requirements for well boards.

2.2.5 Coil wells

- The sides of the well should have an minimum angle of 30 degrees to the horizontal.
- A coil placed in the well must be clear of the bottom by at least 20 mm.
- The points of support of the coil must be distinctly lower than the upper rim of the well.

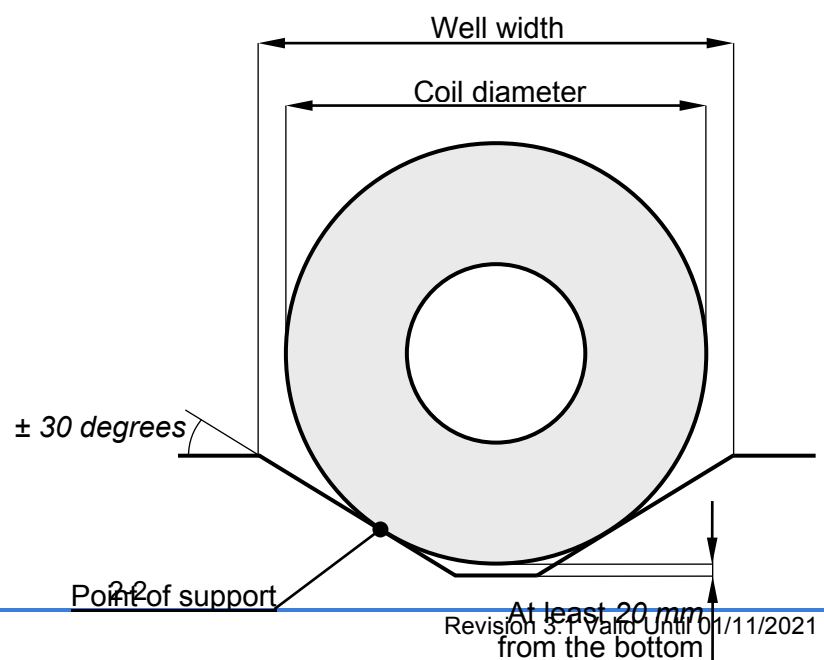

2. Equipment requirement

- When it is unclear if the coil lies correctly in the well, a sheet of paper will be used to check that the point of support is lower than the upper rim of the well.
- For UK loads the coils wells must have timber on both sides along with rubber lining or strips (minimum rubber thickness = 10 mm)

2.2.6 Stanchions (coil securing posts)

- The use of stanchions is recommended, especially for coils in a well. The use of stanchions is mandatory for transport of coils sensitive for tipping and/or are of 10 tonnes or more in weight. Refer to LRG-0008-BH for further information on topple sensitive coils, coil weights and stanchion specifications.
- The use of stanchions is allowed in combination with all securing methods for horizontal and vertical (ETTS) coils and Tinplate sheet packs.
- A driver must ensure that the coil securing posts are according to the required standards as stated in the Load Restraint Guideline.
- In order to assist in the loading, process the stanchions should be at least as high as half the height of the coil when placed in the well.

2.2.7 Lashing points

- The lashing points should be integrated in the vehicle construction.
- Each lashing point should be capable of withstanding the prescribed forces as described in the Load Restrain Guideline for the load to be transported.
- Rope hooks may never be used as lashing points
- There should be enough lashing points for securing according to the prescribed securing methods.
- The side rave (chassis rail) may only be used for the side to side straps for the TSP sheet packs. All other securing methods require the use of specially designed lashing points (including original equipment punched side raves).

Go / No-go standard

- Damaged or excessively worn lashing points may not be used.
- The web lashing or chain end fitting must be suitable for and fit fully within the lashing point.

2. Equipment requirement

2.2.8 Weather superstructure

- Products must be covered in such a way that they remain dry.
- The weather hood must be retractable so that it does not interfere with the loading process.
- When the weather hood is not retractable it should be possible to remove the weather hood rapidly and in a way that the driver can always work safely on the trailer bed.
- Trailers which have a framework and cover to be disassembled before loading and have to be setup after loading, are not permitted.
- The weather superstructure must be at least 10 cm above the load.
- The weather hood should not have any tears or other deficiencies that could result in leakage.
- Rear doors or curtains must be weatherproof and kept closed at all times other than during loading.
- The sole purpose of the trailer canopy is to protect the load from the weather and under no circumstances is it to be used as part of the load restraint system.
- When loading ETTS coils, tinplate packages or horizontal coils on a Tata Steel Skid/Pallet the trailer must be accessible from the back and the side.

2.2.9 Roof Pole

- The roof should always be opened with suitable equipment (roof pole).
- The roof pole must be in good condition and well-maintained.
- Before using a telescopic roof pole, one must determine the locking pin functions correctly and that the pole can be used safely.

2.2.10 Sheeting

If sheeting is required it must be:

- Clean.
- Good quality and free from holes and tears.
- Able to fully cover the load and the trailer floor from the headboard up to and including the load.

2. Equipment requirement

2.3 Securing Equipment Requirements

2.3.1 Webbing straps and ratchets

Requirements

- Straps should demonstrable comply with the EN12195-2 standard, by means of a label on the web lashing and a classification on the ratchet.
- The strap must have a hand-operated ratchet tensioner.
- The length of the straps must be sufficient for the securing method. Straps with a minimum length of 8.5 m are required for securing ETTS coils.
- Straps should be visually inspected before every journey.
- The end fitting of the strap must be suitable for the type of securing point used.
- Refer to Technical Information Sheet TIS-0003 for further requirements for web straps and ratchets.

Go / No-go standard

- Webbing straps should not be used that exhibit damage and wear that equates to 10% or more of the material. Holes in the web lashing are not allowed.
- In accordance with EN12195-2, TIS-0003 and information from the manufacturer.

2.3.2 Transport chains and tensioners

Requirements

- Lashing chains must demonstrable comply with the EN12195-3 standard, by means of a metal tag attached to the chain.
- Lashing chains should be visually inspected before every journey.
- The use of spring links (over centre load binders) is not permitted.
- The end fitting of the chain must be suitable for the type of securing point used.
- Refer to Technical Information Sheet TIS-0004 for further requirements for transport chains and tensioners.

Go / No-go standard

- Chains should be replaced when they are bent, twisted, gouged or excessively worn (10% or more of the original diameter).
- In accordance with EN12195-3, TIS-0004 and information from the manufacturer.

2. Equipment requirement

2.3.3 Webbing strap edge protection

Requirements

- Edge protectors must consist of products specifically designed for purpose thereof. The use of friction enhancing material (anti slip matting) is not permitted.
- The use of edge protection is mandatory for loads where the edge radius is less than the thickness of the web lashing used.
- The shape and size of edge protectors must fit the used loading restraint material.
- Refer to Technical Information Sheet TIS-0005 for further requirements for webbing strap edge protection.
- If in doubt as to whether edge protection is needed or not, apply it.

No-go standard

- An edge protector needs replacement when damage to the protector hinders the correct working of the protector therefore leading to the possibility of damage to either the webbing strap or the load.

2.3.4 Anti-slip matting

Requirements

- The anti-slip mats should have minimum friction coefficient (μ) of 0.6 or more.
- The anti-slip mats should have a thickness of at least 8 mm.
- When used for TSP ETTS coils, Sheet packs, Vertical slit coils and Bore horizontal coils on cradles the anti slip mat must not be thicker than 10 mm, for all other products a maximum limit of 25 mm will be adhered to.
- Refer to Technical Information Sheet TIS-0008 for further requirements for anti-slip matting.

Use

- Anti-slip mats must be placed in a way the load doesn't touch the trailer bed directly and will not touch the trailer bed after a small movement of the load.
- Anti-slip mats must remain partly visible when placed under a load.

No-go standard

- When the anti-slip mat is breaking apart the material should be replaced.

2. Equipment requirement

- When the friction coefficient of the anti-slip mats is questionable, the driver or carrier will have to prove that the mats have the required friction coefficient.
- Old conveyer belt, bike tyre and so on are not anti slip material.

2.3.5 Horizontal wooden dunnage and metal posts (as required by LRG-0008-BH)

Requirements

- Wooden posts:
 - Wooden posts used as blocking between the posts and the coil should have a nominal dimension of 100 x 100 mm.
 - To allow for shrinkage and sawing tolerances, a tolerance of -10 mm will be applied during any control. However, the **ABSOLUTE** minimum dimension for any section of the wooden dunnage is 90 x 90 mm.
- Steel posts:
 - Steel posts used as blocking must be a minimum 80 x 80 mm with a thickness of 5 mm.
 - Anti slip may must be placed between all steel posts this includes between the trailer floor and the first post. This is to prevent the posts from sliding sideways.

No-go standard

- Posts must extend beyond outer edges of the trailer well and well posts.
- Cracked, split or bent posts must not be used.

2.3.6 Timbers and wooden dunnage.

Requirements

- Timbers are to be made from 1st grade softwood or better,
- Base timbers must span full width of trailer.
- Square timber is recommended but rectangular timber can be used if the timber is placed with its shortest dimension vertical.
- Special rules apply for stacking dunnage. Refer to product specific Load Restrain Guideline or Technical Information Sheet TIS-0002, Timber dunnage for information on stacking dunnage.

No-go standard

- Do not use timbers with damaged or crushed corners

2. Equipment requirement

- Do not use if corners are rounded off by 10 mm or more.
- Damaged timbers are weak replace any timbers that are split or cracked.

2.3.7 Coil Cradles

When a horizontal coil has to be transported on a trailer without a well the coil can be supported by a cradle. The requirements of the cradle are as follows:

- The cradle should provide a stable support for the coil.
- The beams that support the coil must cover the full width of the coil.
- There must be provisions for fixing the distance between the beams in both directions.
- The points of support of the coil must be distinctly lower than the upper edge of the cradle.
- A coil placed in a cradle must be clear of the loading platform or cradle construction for at least 20 mm.
- The use of anti-slip mats between the loading platform and the coil cradle is mandatory when the cradle is not fixed to the trailer.

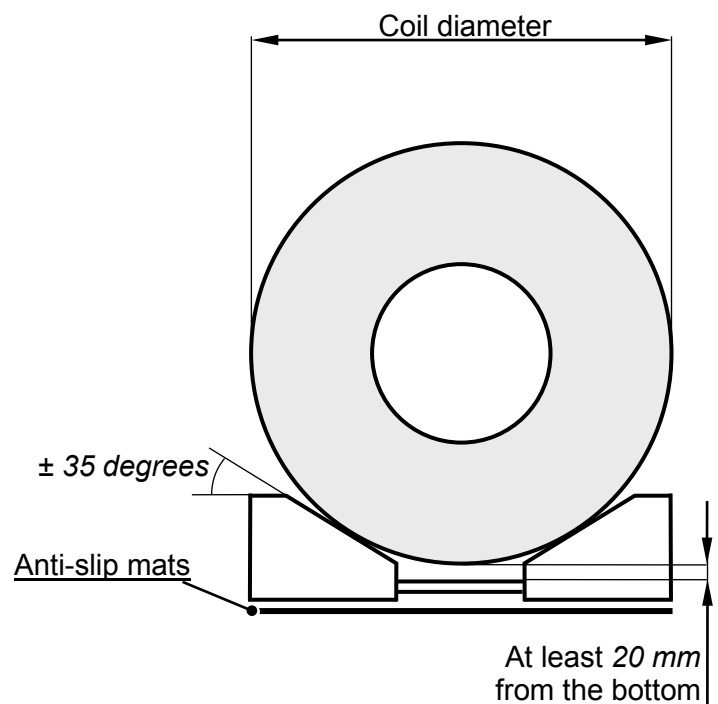

2.3.8 Stillages

- Stillages must fit the coil to be transported.
 - A stillage should not be too large so it cannot sufficiently support the coil.
 - The stillage should not be too small so that the coil lies on the edge of the stillage.
- Stillages must be in a good condition.
- Stillages are to be used only in combination with blocking in forward direction using either stanchions or a headboard.

2. Equipment requirement

2.4 Technical Information Sheets (TIS)

2.4.1 Description

These technical information sheets represent the Tata Steel Europe requirements for haulier equipment. Hauliers are required to conform to these requirements when the equipment is used to restrain Tata Steel Europe products. Failure to meet these requirements can lead to the load being refused.

The technical information sheets that are applied per product can vary. It is therefore necessary to contact the local Tata Steel contact for the Technical Information Sheets that are in use for the products to be transported.

3. Co-loads (additional cargo)

3.1 Types of Additional Cargo

- All non-Tata Steel material is considered additional cargo, this includes haulier equipment within the trailer.
- A driver is required to have information concerning the co-load which includes a description and the gross weight of the load.
- Tata Steel may request at any time, a description including the gross weight of any cargo to be transported together with Tata Steel material

3.2 Prohibited Co-loads

3.2.1 Items not permitted









Items not permitted include

- Perishable goods
- Additional cargo damaging the packaging and Tata Steel products.
- Loose bulk materials
- Additional cargo not fitting within the dimensions of the trailer.
- Additional cargo or residue thereof affecting the Tata Steel products by its odour or by contamination. Therefore, empty packaging from chemicals is also not permitted.
- For Tata Steel Packaging (TSP) products special HA.CCP rules apply with regards to food hygiene. Questions concerning these rules should be directed to the consignee.

3.2.2 Hazardous Co-loads

Not permitted are:

- Chemicals (toxic, noxious, irritating or corrosive products) or explosive goods.
 - Co-loads that exhibit the following GHS symbols are not allowed:

- | | | | |
|-------------|---|--|--|
| ▪ Explosive |  |  | ▪ Acutely toxic |
| ▪ Flammable |  |  | ▪ Irritating
Sensitizing
Harmful |
| ▪ Oxidant |  |  | ▪ Long term
health hazard |
| ▪ Corrosive |  |  | ▪ Hazardous to
aquatic
environment |

3.2.3 Harmonisation System (HS) Codes

Goods with the following codes under the ‘Harmonized Commodity Description and Coding System 2012’ are not allowed in combination with Tata Steel product. The type of co-loads allowed varies depending upon the Tata Steel product, Tata Steel Packaging (TSP) or Tata Steel Strip Products (TSSP): -

TSP (Packaging)	
01 --	28 --
02 --	29 --
03 --	30 --
04 --	31 --
05 --	32 --
06 --	33 --
07 --	34 --
08 --	35 --
09 --	36 --
10 --	37 --
12 --	38 --
13 --	41 --
14 --	43 --
15 --	47 --
16 --	6701
17 --	6703
18 --	6704
19 --	68 --
20 --	70 --
21 --	8401
22 --	8505
23 --	8506
24 --	8507
25 --	8710
26 --	93 --
27 --	9601

TSSP (Strip)	
01 --	2710
02 --	2711
03 --	28 --
04 --	29 --
05 --	3001
07 --	3002
08 --	36 --
1501	4101
1502	4102
1503	4103
1504	43 --
1505	6701
1506	6811
16 --	6812
2203	8401
2204	8505
2205	8506
2206	8507
2207	8710
2208	93 --
2709	9601

- Numbers shown as ## --. Indicate that all products within that group are prohibited.
- Numbers shown as ####. Indicates a sub-group that is prohibited.

In all cases products displaying warning labels such as described in section 3.2.2 over rules any description in the above list. A full list of the above products is available upon request.

3.3 Loading and Unloading

- Additional cargo must not delay loading at Tata Steel.
- Additional cargo must not delay unloading at the customer's premises.
- Additional cargo must not affect the delivery time that has been agreed with the customer.
- Preferably, the Tata Steel products should be loaded first and then the additional cargo.
- If additional cargo is loaded first and then problems arise with the loading of Tata Steel material, any resultant costs may not be claimed from Tata Steel.

3.4 Load Configuration and Securing

- A minimum distance of 500 mm should be left between the Tata Steel load and the co-load.
- Many customers require the trailer to be accessed via the rear doors. Provision should be made for this.
- All additional cargo and haulier equipment (well boards for example) must be adequately secured with approved securing materials to prevent shifting.
- The web lashing on the Tata Steel products are not to be loosened or removed to place additional cargo on the trailer.

Additional restrictions for TSSP material

- When transporting or loading Tata Steel Packaging (TSP) ETTS coils additional cargo is only permitted on the first four meters of the trailer.
- In case of a combination truck additional cargo is only permitted on the first two meters

3.5 Exceptions

- For some customers no additional cargo is permitted at all.
- When three or more ETTS coils are to be transported, no additional cargo is allowed.

4. Return Loads

4.1 Responsibility

Should it be required to return material to Tata Steel then this material should be prepared in such a way that it is suitable for handling and transportation.

Coils and sheet packs that are to be returned to Tata Steel by Road transport have to be transported in a safe manner according to European and Local regulations. Tata Steel has developed securing methods to secure its products and these are also to be used for return loads. Packaging plays a key roll in the securing of a load. Poor packaging can compromise the securing system and damage the restraint equipment used by the haulier.

4.2 Packaging

- Whenever possible the returning of Tata Steel material should be done in the original packaging. The packaging must be removed when it affects the safe transport of the material.
 - Due to safety reasons broken banding must always be replaced prior to transport.
- Horizontal coils must be transported on a suitable coil well trailer or using a cradle or stillages in case of a flat trailer bed. See 2.3.5/6 for the requirements of cradles and stillages.
- Unused ETTS coils in the original Tata Steel packaging should be returned on an ETTS pallet when possible. When this is not possible the coil must be transported on a wooden/steel ETTS pallet. The TSP sales department can arrange for this pallet to be provided. Full edge protection (original) should be applied and affixed to the upper edge of any unpacked ETTS coil.
- There is a separate information document available for the preparation for coils that are to be returned to Tata Steel. This document is available upon request.

4.3 Securing

- Return loads must be secured as per the Tata Steel securing guidelines/methods.

- **Blank page**

5. Securing methods

5.1 Description

Tata Steel has developed and implemented Load Restraint Guidelines (LRGs) for many of the products transported from sites of Tata Steel Europe. These must be applied where present. Where an LRG has not been developed for a particular product, either local guidelines should be followed or if these are not available basic principles applied.

All Tata Steel products must be secured so as to be compliant with the forces as specified in EN 12195, as described in section 5.3 Basic Principles.

Hauliers are required to provide all necessary equipment and facilities required to meet the Tata Load Restraint standard. Hauliers are required to remove and replace all defective equipment

5.2 Securing Methods/Guidelines

The methods/guidelines that are applied per location differ. It is therefore necessary to contact the local Tata Steel contact for the guidelines that are in use for the products to be transported.

5.3 Basic Principles

For road haulage, EU legislation calls for the load to be secured to withstand: -

- 0.8 'g' forward acceleration (80% of the weight of the load directed forward).
- 0.5 'g' lateral acceleration (producing a force equivalent to 50% of the weight of the load directed sideways).
- 0.5 'g' rearward acceleration (50% of the weight of the load directed rearwards).

For intermodal transport including rail or sea transits, the load securing requirements may differ from this and must take account of the "worst case" scenario.

5.4 Winter Weather Conditions

During winter months, additional load restraint is required for open trailers when freezing conditions are likely to be encountered. A series of Technical Advice Documents (TAD 0021a–n)

has been published, to show how this applies to a range of products likely to be affected by winter conditions

In the UK a system has been put in place to notify loading teams and hauliers when additional restraint is required.

6. Accidents and incidents

6.1 Accidents

Any driving incidents or accidents involving vehicles carrying Tata Steel products must be reported to Tata Steel Outbound Quality and Transport Safety within 24 hours. Incidents and accidents includes but is not limited to road traffic accidents, loss of control of vehicle, attempted theft leading to possible damage to vehicle and/or load.

Emergency braking without loss of control of vehicle does not have to be reported. The driver must however must find a safe place to stop and check the securing of the load after an emergency stop.

Products damaged during these incidents must not be delivered/unloaded at the destination without first obtaining permission from Tata Steel.

6.2 Unauthorised access and malicious damage

Any attempt by a third party to gain unauthorised access to the load area, whether successful or not must be reported to Tata Steel . All products in the load area must be inspected for malicious damage or contamination.

Any contamination or damage to the product (including the packaging) must be recorded using photographs and reported to Tata Steel. The product may not be delivered/unloaded until permission has been given by Tata Steel.

6.3 Contamination

Any contamination to the product must be recorded using photographs and reported to Tata Steel. The product may not be delivered/unloaded until permission has been given by Tata Steel.

A sample of the contaminant must be retained for possible testing.

7. Organisation and management

7.1 Application

7.1.1 Responsibility

- Carriers are responsible for providing safe and damage-free transport. This document describes the minimum requirements. It does not relieve carriers from responsibility for taking additional measures as he may deem necessary. Carriers retain full liability.

7.1.2 Application

- These regulations apply for all road transports departing in Europe under responsibility of or ordered by Tata Steel Europe Strip Products
- These regulations also apply for all road transports outside continental Europe when agreed so with the service provider.
- In the USA all loads must be secured according to the standards as described in the current version of the 'Federal Motor Carrier, Safety Regulations'.
- These regulations do not include all onsite warehouse and dispatch regulations. For these local regulations dedicated arrangements will be provided.

7.1.3 Inspection

- Checks will be performed on the basis of our minimum requirements as described in parts 1 through to 4 of this document.
- Checks may be performed during loading, in transit or at the unloading location.
- Vehicles that do not meet the minimum requirements will be refused the load.
- If it is established that a driver has not secured the load in accordance with the regulations or has not the right securing equipment, the transport will be halted. The person who performs the check will decide whether the failing can be rectified. If the carrier cannot meet the minimum requirements, the trailer will be unloaded and have leave empty.

7.1.4 None-conformance system

- Tata Steel works with quality system wherein deviations in relation to the regulations are handled through a so called none conformance system.
- The none conformance system rates a violation with an 'C' category for a minor violation up to a 'A' for a major violation.
- The registered none conformances have a validity of 1 year.
- The none conformances are assigned when the deviation is culpable.
- None conformances can lead to a suspension of a driver or haulier for Tata Steel transports for a (in)definite period of time.

7.2 Document Control

7.2.1 Publication method

- The Quality and Transport Safety Department (QTS) of Tata Steel Supply Chain Europe, Outbound is charged with the publication of the Road Regulations.
- QTS will maintain a record of the publication of the controlled copies so that amendments can be made in all relevant departments.
- The current version of the Road Regulations will be available on a Tata Steel internet site anytime on the URL: <http://www.tatasteel.nl/veiligheid/en>.
- Under Regulations > Transport en logistics > Road Standards.

7.2.2 Validity

- This document remains valid up to and including the 31st October 2021 but can be amended when necessary.

7.2.3 Archive

- Records of the Road Standards will be archived for at least 3 years.
- Authorisations will be archived until they are replaced by a new authorisation about the same piece of the Road Regulations.

7.2.4 Authorisation

- QTS will consult and inform all relevant departments and the forwarder when intending an alteration.
- QTS will present every amendment to the QTS Manager for authorisation.

7.2.5 Change list

Terminated

- No Sections terminated

Changed

- Organisation and management, was (6) is now (7)

New

- Accidents and incidents (6).