

TECHNICAL INFORMATION SHEET

Controlling gaps in loads

1. Purpose

Gaps are often required between bundles of product in order to allow loading or unloading with overhead crane and slings. Leaving these gaps uncontrolled introduces another element of risk to safe transport of the product.

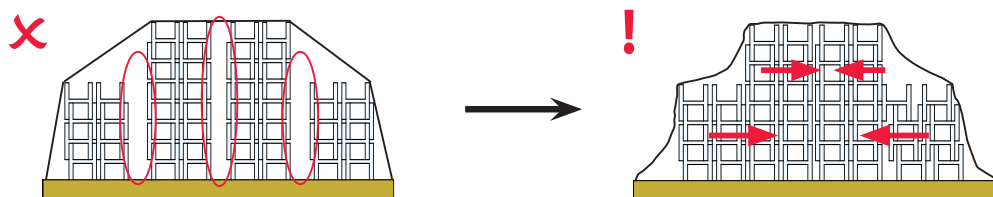

When gaps are uncontrolled, vibrations experienced in transit and twisting of the trailer frame can cause the product to move. As this happens, the gaps close up and the tension in the restraints can reduce significantly or be lost entirely. Alternatively, the restraints will not be able to restrain the load, for example during an emergency braking situation, causing product to spear forwards or backwards.

Examples of gap blocking are shown below.

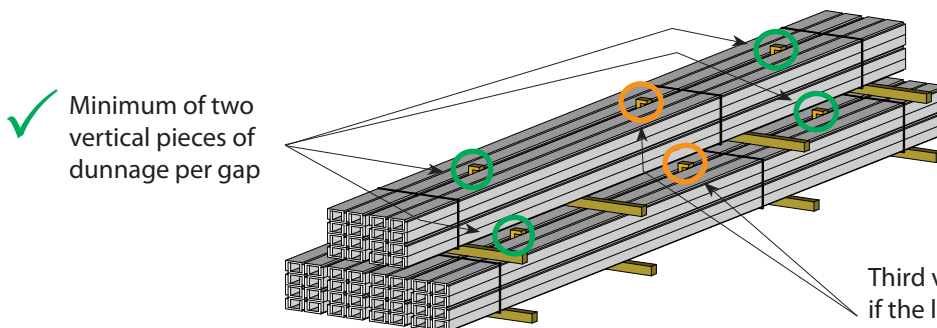

2. Key points

There are a variety of methods by which chain gaps can be maintained without compromising the safe transport of the product. Solutions will vary depending on the product type and the set-up of the loading or unloading site.

Vertical dunnage should:

- ✓ Be placed so that it cannot move from its position whilst in transit.
- ✓ Be secured so that it cannot fall from the vehicle.
- ✓ Be suitable for the load; not all types are suitable for all products.
- ✓ Where possible be placed on the load whilst it is still on the ground, eliminating the need to get onto the trailer.

TECHNICAL INFORMATION SHEET

Controlling gaps in loads

3. Blocking situations

Examples when vertical dunnage is necessary in the top layer only

In the following examples there is sufficient clamping of the lower layers to prevent them moving sideways in transit. Therefore vertical dunnage is only required in the top layer.

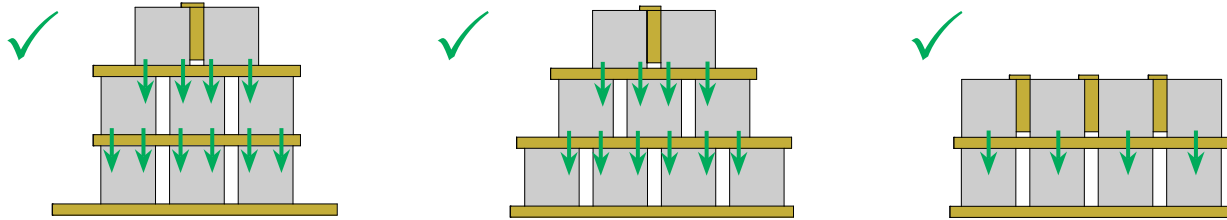

Examples when vertical dunnage is required in the intermediate / bottom layer

Vertical dunnage should be used in the intermediate / bottom layer if the layer above does not sufficiently clamp the product in the layer below.

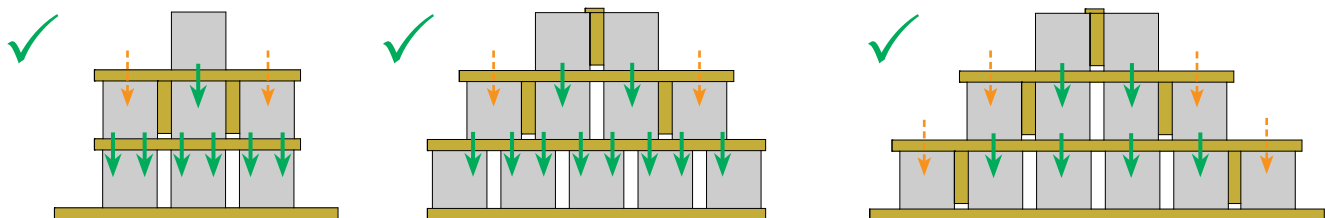

4. Options available

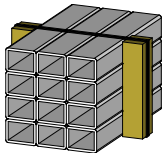

Timber blocks incorporated into product banding.

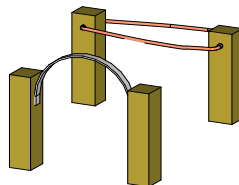

Nunchuks. Lengths of timber connected by rope, webbing or steel strapping.

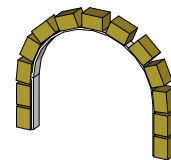

Small blocks of timber connected by webbing.

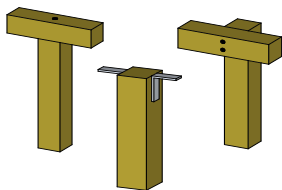

Wooden tee or timber with metal brackets.

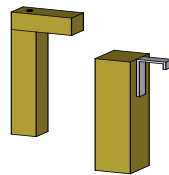

Timber with metal hook. Particularly suitable for universal beams and columns.

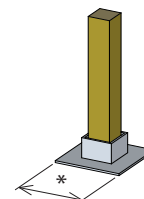

Post stands to support simple timbers.

*Sides of base plate must be at least 2x height of base dunnage.

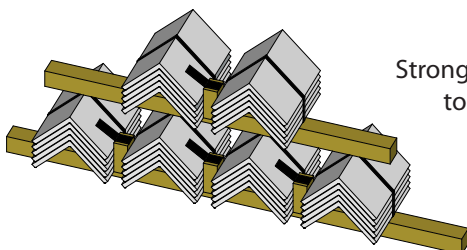

Strong adhesive tape has been used successfully to keep timber blocks fixed to the product when the load is sheeted or loaded into covered trailers.

Timber blocks are attached to the product on the ground before loading commences.

Care has been taken to ensure that the contents of this publication are accurate, but British Steel Limited and its subsidiaries do not accept responsibility or liability for errors or information that is found to be misleading.